

Skán



Design by Lievore, Altherr, Molina.

Minimal volume and maximum lighting functionality. Skán represents a return to what is essential: pure, delicate lines in which the light is the fundamental element while the shape is almost invisible.



Skans sleek disc design is defined by its pure form and simple lines. Like an elegant bird hovering overhead, it's suspended from a long, lean cable. The LED-powered pendant features a steel canopy and diffuser that casts a broad, bright dimmable light. Streamlined and understated, it lends a quiet elegance to any space as a single lamp or in a grouping of three or five pendants.

- 10 White (NCS S 0300-N)
- 11 Black (NCS S 8500-N)
- 24 Beige M1 (NCS S 2500-Y50R)
- 37 Terra Red (NCS S 4040-Y70R)
- 42 Blue M1 (NCS S 5010-B10G)
- 47 Green L1 (NCS S 4005-G80Y)

Shade: Aluminum.

Diffuser: Methacrylate.

Ceiling rose: Steel.

LED 2700 K. CRI>80. 106 lm/W.

Ref. 0270.

Dimming: 0-10V.

Ref. 0271, 0275, 0276, 0280, 0282.

Dimming: 1-10V, Push.

Ref. 0270, 0275, 0280, 0282.

Surface mounted.

Ref. 0271, 0276.

Built-in.

Personalization options available

- Finish customization
(Available options: Vibia color palette)
 - LED 3000 K / 4000 K
 - Dimming: DALI, Casambi
 - Extra cable length
- Request more information.

0270

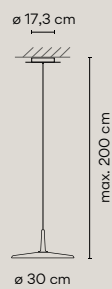

0271

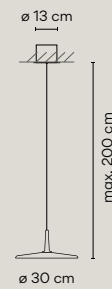

0275

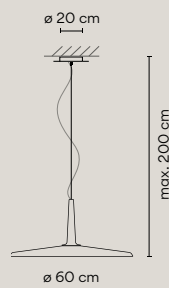

0276

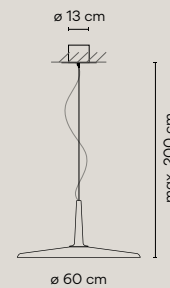

0280

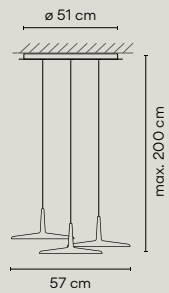

0282

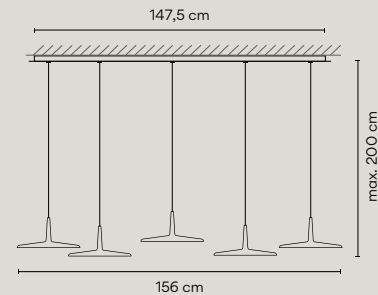



Skán

Design by Lievore, Altherr, Molina.

Skán is marked by its minimalist design and purity of form. The fixture includes a single-stem reading light with a swiveling cubist shade and a standing luminaire composed of three intertwined stems.





Skans sleek silhouette is marked by its minimalist mien and fluid form. The LED-powered floor lamp includes two options: one is a pitched, single-stem reading lamp that features a weighted base and a swiveling cubist shade that casts a wide beam of light; the other version features three slender, intertwined stems that recall a stand of trees in the forest and emit a diffuse, upward glow from the disc-shaped shades. Both are dimmable.

- 10 White (NCS S 0300-N)
- 11 Black (NCS S 8500-N)
- 37 Terra Red (NCS S 4040-Y70R)

Head: Aluminum.
 Diffuser: Methacrylate.
 Base: Zamak.
 Vertical Rod: Steel.

Ref. 0250.
 LED 3000 K. CRI>80. 42,4 lm/W.
 Dimming: Optical sensor on the head.

Ref. 0260.
 LED 2700 K. CRI>80. 97,1 lm/W.
 Dimming: Push button on the cable.

Personalization options available

- Finish customization
 (Available options: Vibia color palette)

Ref. 0260.
 - LED 3000 K / 4000 K
 Request more information.

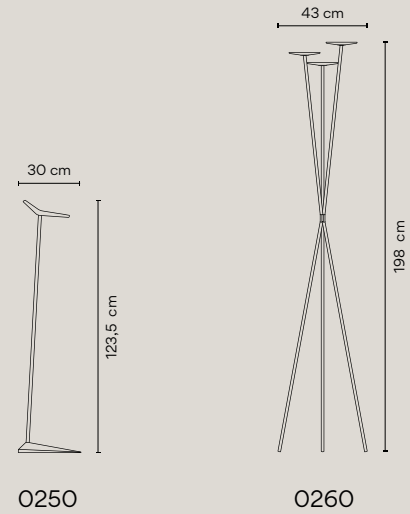

0250

0260

